

2024 ZHEJIANG WUYI JIA MIN LOCKS CO.,LTD



www.locks-factory.com

ACCESSORIES FOR
DOOR & HARDWARE

- Mortise locks
- Lever handles
- Lock cylinders

Contents

01 / **Mortise Locks**

---Center 85,72, 58,55,50, 92 Series ----- 02-06

---Center 68 Entry Doors Series ----- 07-13

02 / **Lever Handles**

----- 16

03 / **Fire Door Handles**

----- 17-19

04 / **Door Locks Handles**

----- 20-22

05 / **Lock Cylinders**

----- 23



企业简介

ENTERPRISE INTRODUCTION



浙江武义佳民锁业有限公司2009年成立,位于中国浙江武义县王宅工业区,公司占地面积 30000 平方米,是一家集锁具开发、设计、制造、销售为一体的专业化公司。公司技术力量雄厚,现有员工200多人,凭借丰富的生产经验和专业的管理技术,努力完善自身产品品质,不断开拓创新。公司产品以及其可靠的性能、时尚的款式、合理的价格深受广大客户的青睐,销售网络遍布全国和世界各地。

佳民锁业公司主营防盗门锁具、室内门锁具等。外观优雅,性能稳定,具有很强的防盗性、艺术性、时尚性,现以被众多防盗门厂家选用。“佳民”发展具有强大的生命力,我们为创建一个优秀品牌而奋斗。

公司秉承“专业、匠心、诚信、服务”的经营理念,打造“佳民”优秀品牌。坚持“客户第一,诚信为本”的原则为广大客户提供有优秀的服务。在迎接新一轮市场经济的浪潮中,我们将一如既往的以热枕饱满的精神与您携手并进,让更多人感受到佳民,感受品质与科技的完美结合。热烈欢迎各界的朋友前来参观,考察,洽谈业务。

Zhejiang Wuyi Jiamin Locks Co, Ltd. was established in 2009. It is located in WangZhai Industrial Zone, Wuyi County, Zhejiang, China. The company covers an area of more than 30,000 square meters and is a specialized company integrating the development, design, manufacture and sales of locks. The company has strong technical force and more than 200 employees. With rich production experience and professional management techniques, it strives to improve the quality of its products and constantly explores and innovates. The company's products, as well as its reliable performance, fashionable style, and reasonable price, are favored by customers, and its sales network has spread all over the country and around the world.

Jiamin Lock Company is mainly engaged in anti-theft door locks and interior door locks. With elegant appearance and stable performance, it has strong anti-theft, artistic and fashionable feature. Now it is selected by many security door manufacturers. The development of “Jiamin Locks” has a strong vitality. We strive to create a good brand.

Companies have adhering to the “professional, ingenuity, integrity, service” business philosophy and Created “Jiamin Locks” outstanding brands. Adhere to the “customers first, integrity-based” principle to provide our clients with excellent service. In the monment of the new market-economy's trend, we will work with you hand-in-hand enthusiastically as always, so that let more people to feel the “Jiamin Locks” and experience the perfect combination of quality and technology. Warmly welcome the friends from all walks of life to “Jiamin Locks” for visiting, inspecting and negotiating the business.

锁体系列
LOCK BODY SERIES



Euro Mortice Lock case JM8545 Series

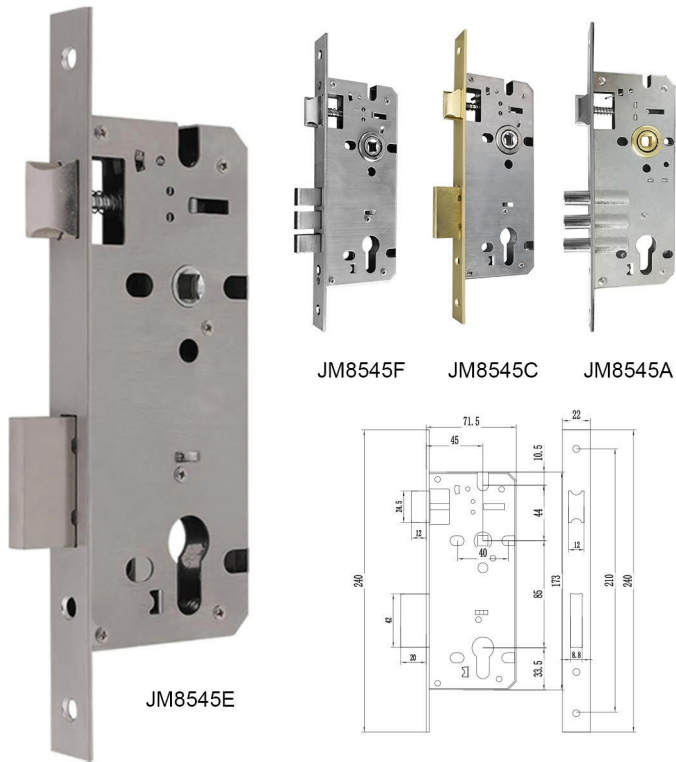

features:

- * Lock case: galvanized sheet steel
- * Forend material: stainless steel or steel
- * Dead bolt durability: 50000 tested cycle
- * Latch bolt durability: 200000 tested cycle, 120N side pressure
- * Spindle hole: 8x8mm
- * Surface treatment: satin brushed SS or any electric plating color
- * The performance according to EN12209 and DIN18251

Suggested choice: JM8545-FS-23-240-55-85-SS-SS-SS

Forend:	FS			
Forend width:	23			
Forend length:	240			
Backset:	45	50	55	60
Center distance:	85			
Forend material:	SS	Steel		
Latchbolt material:	SS	Brass	Zamak	
Deadbolt material:	SS	Brass	Zamak	

Mortice Lock 8525/8530/8535/8540

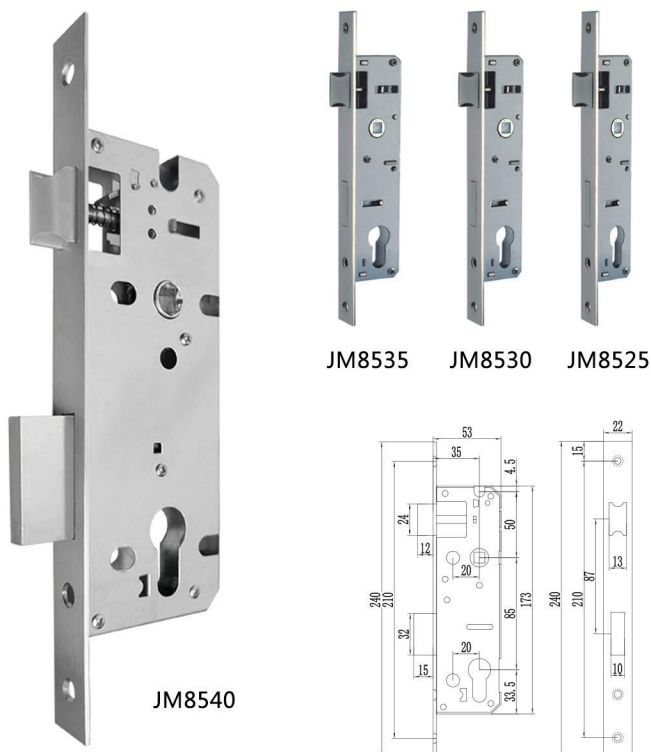

features:

- * Lock case: galvanized sheet steel
- * Forend material: stainless steel or steel
- * Latch bolt: brass
- * Datch bolt: stainless steel(durability: 50000 tested cycle)
- * Forend:SS201,size:240x22x3mm, thickness 3mm
- * Spindle hole size:8x8mm
- * Surface treatment: satin brushed SS or any electric plating color
- * The performance according to EN12209 and DIN18251

Suggested choice: JM8535-FS-22-240-55-85-SS-SS-SS

Forend:	FS			
Forend width:	22			
Forend length:	240			
Backset:	25	35	40	45
Center distance:	85			
Forend material:	SS	Steel		
Latchbolt material:	SS	Brass		
Deadbolt material:	SS	SS+Steel		

Mortice Lock 7040/7250/7255

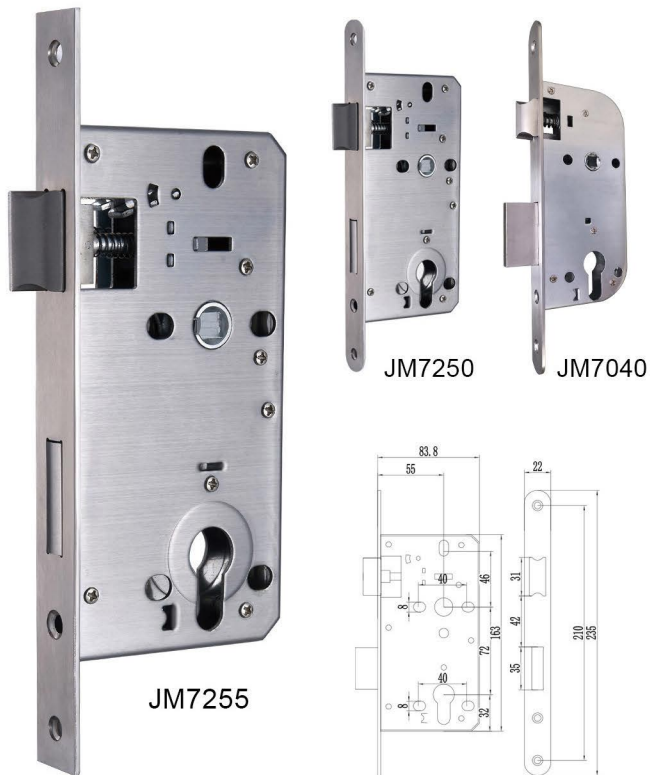

features:

- * Lock case: galvanized sheet steel
- * Forend material: stainless steel or steel
- * Dead bolt durability: 50000 tested cycle
- * Roller latch: brass
- * Spindle hole: 8x8mm
- * Surface treatment: satin brushed SS or any electric plating color
- * The performance according to EN12209 and DIN18251

Suggested choice: JM7255-FR-24-235-55-72-SS-Brass-SS

Forend:	FR	FS		
Forend width:	20	22	23	24
Forend length:	235	240		
Backset:	40	50	55	
Center distance:	72	70		
Forend material:	SS	Steel		
Latchbolt material:	Brass			
Deadbolt material:	SS	Brass	Zamak	

Mortice Lock 5040/5840/5845

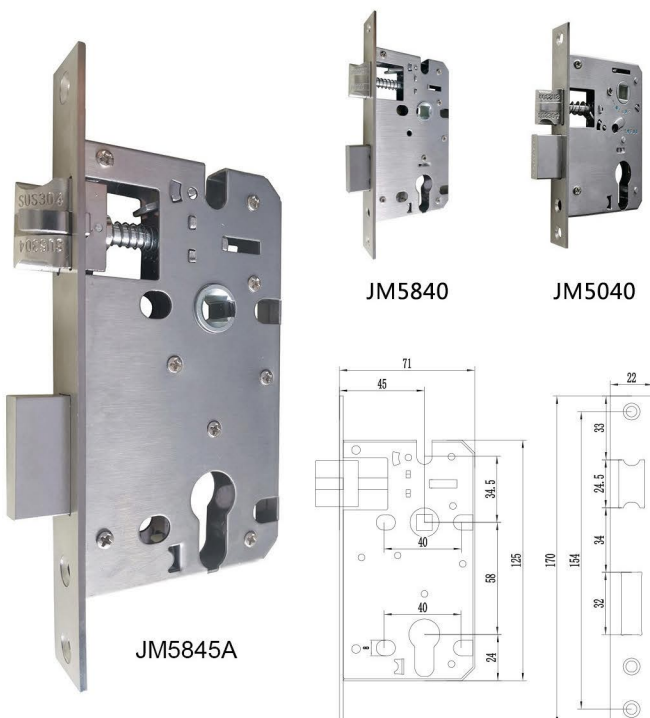

features:

- * Lock case: galvanized sheet steel
- * Forend material: stainless steel or steel
- * Dead bolt durability: 50000 tested cycle
- * Latch bolt durability: 200000 tested cycle, 120N side pressure
- * Spindle hole: 8x8mm
- * Surface treatment: satin brushed SS or any electric plating color

Suggested choice: JM5845-FS-22-170-50-58-Steel-Zamak-Zamak

Forend:	FR	FS		
Forend width:	20	22		
Forend length:	170	180		
Backset:	40	45	50	
Center distance:	58	50		
Forend material:	Steel			
Latchbolt material:	Zamak			
Deadbolt material:	Zamak			



JM5040



JM5045



JM5050



JM5555



JM7045A



JM7045B



JM504



JM7250B



JM7255



JM7568



JM8520



JM8525



JM8530



JM8535



JM8540A



JM8545A



JM8545B



JM8545C



JM8545D



JM8545E



JM8545F



JM8545H



JM8545I



JM8545J



JM8545K



JM8550A



JM8550B



JM8550C



JM8560A



JM8560B



JM8560C



JM8560D



JM501



JM502

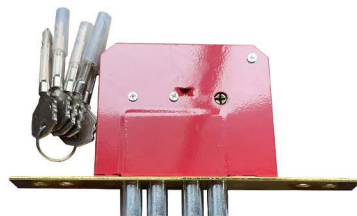

JM503



JM9255

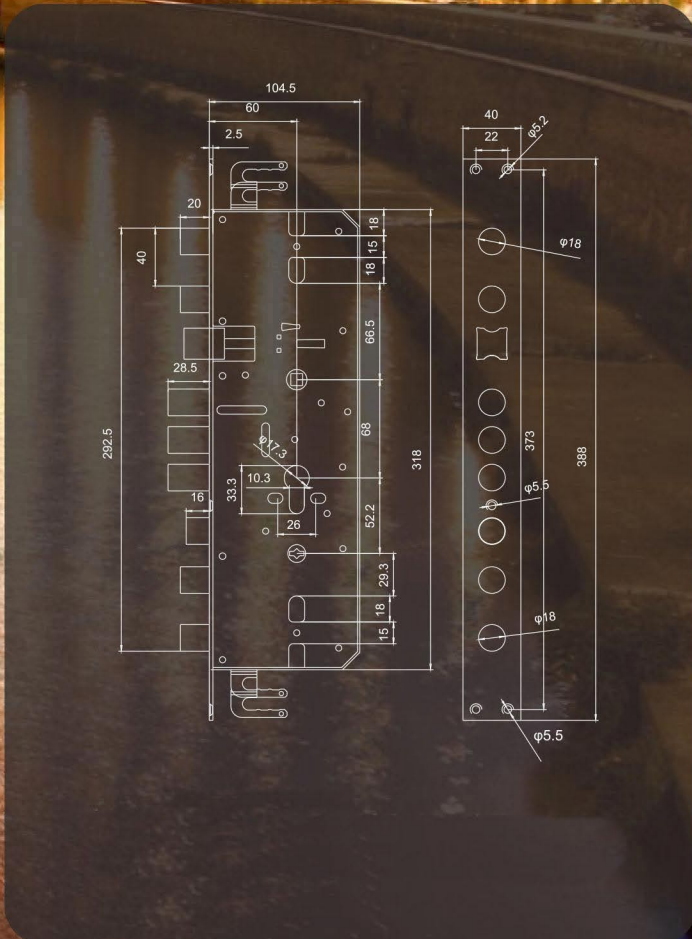
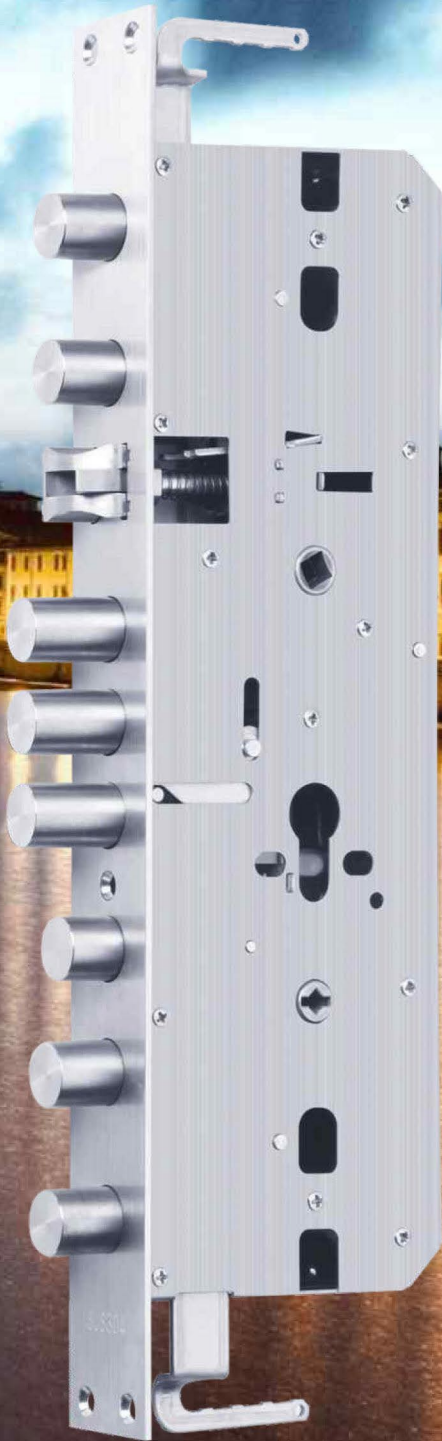

11# 九头多功能锁体
9 latch & deadbolt



10#-1

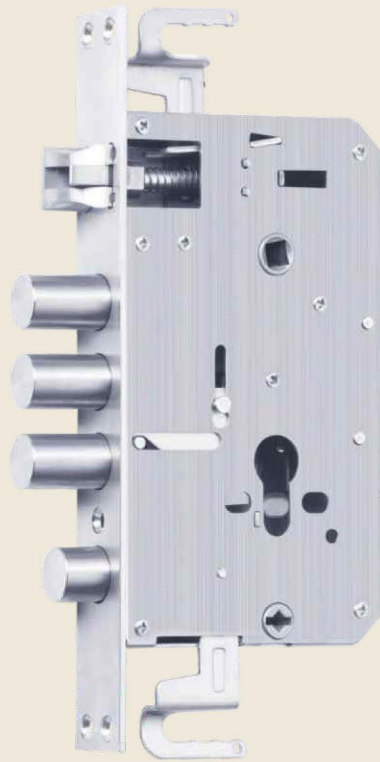

10#-2

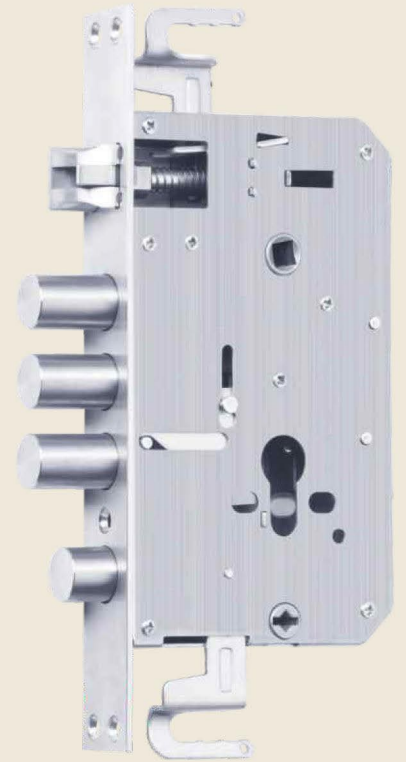

10#-2 **automatic**

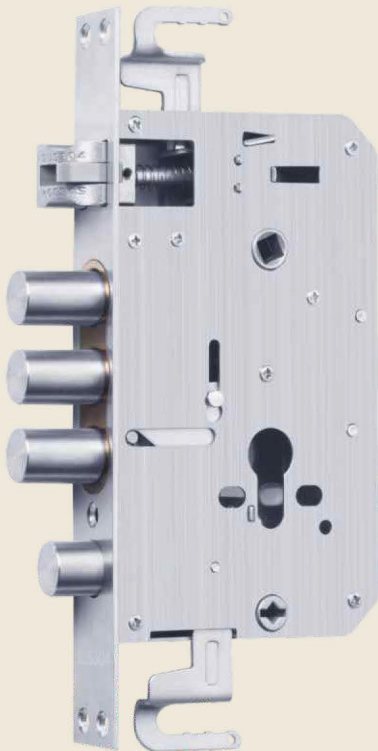

10#-2 **Multifunction**

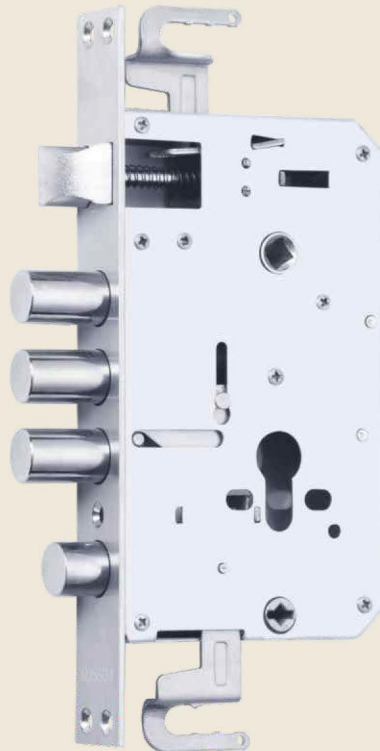

20#

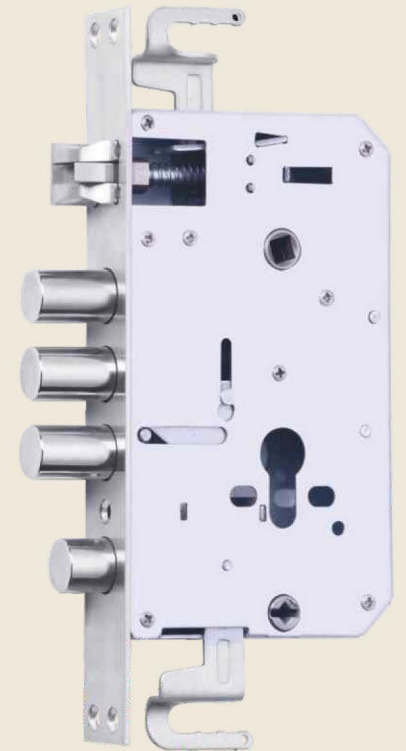

20# **Multifunction**



JM6855

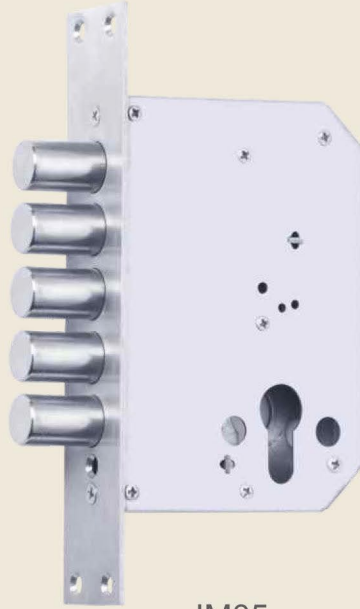

JM05

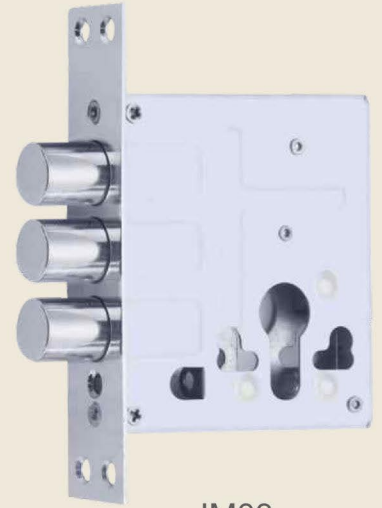

JM03



830g 68/60



JM01



JM-T03

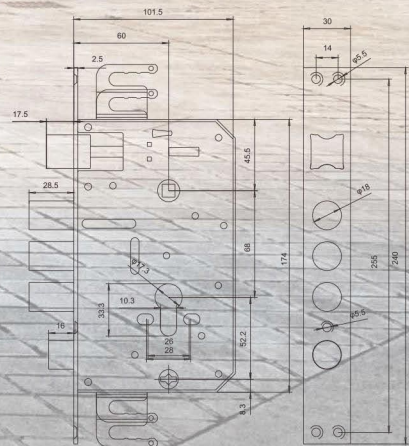
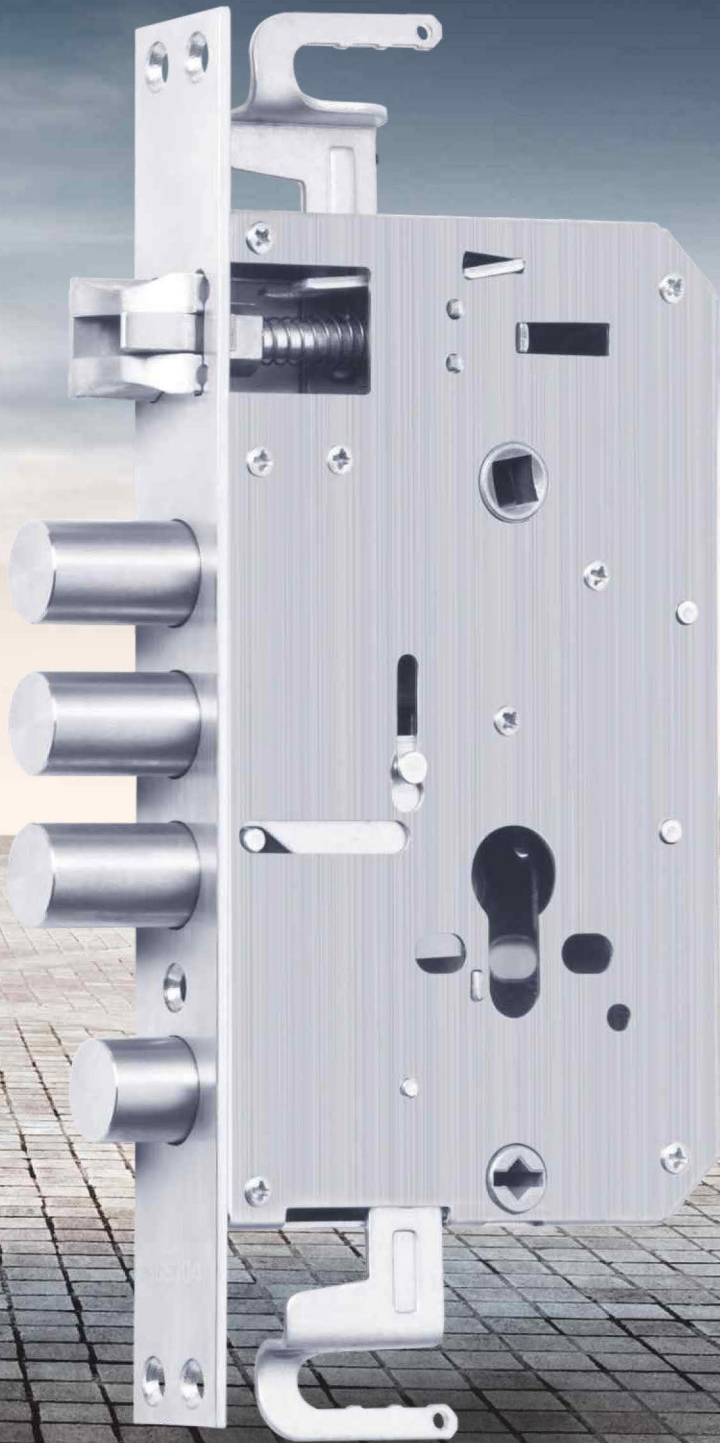

10#



JM99 68/60

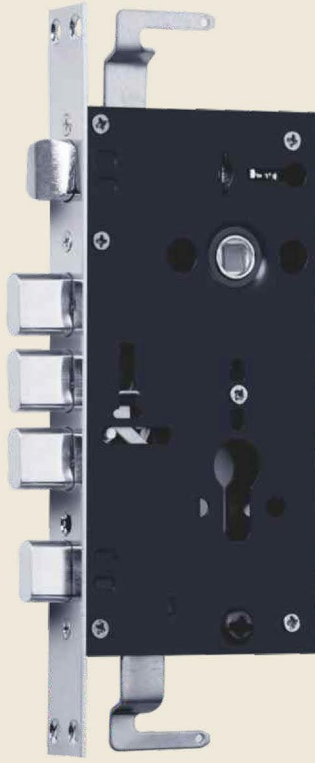

JM10 68/60



JM04



Basket 1.5mm thick

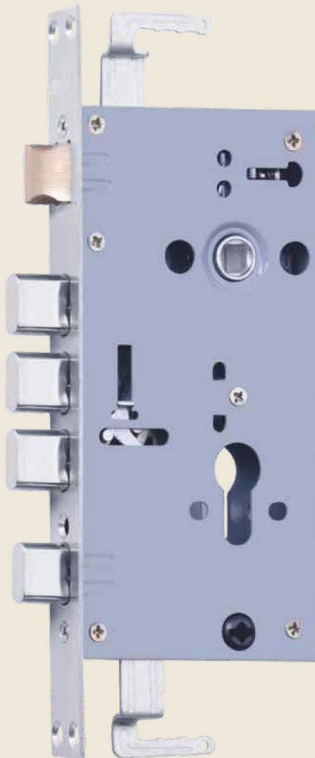

Basket 1.5mm thick



JM7250

92/55

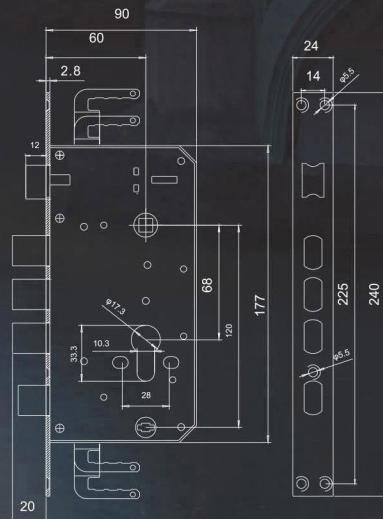

29#全钢多功能锁体安装尺寸

*注：尺寸与常规锁体通



JM72 72/50, 72/55



9#-2 automatic 68/60



19# brass latch 68/60



19# Multifunction 68/60

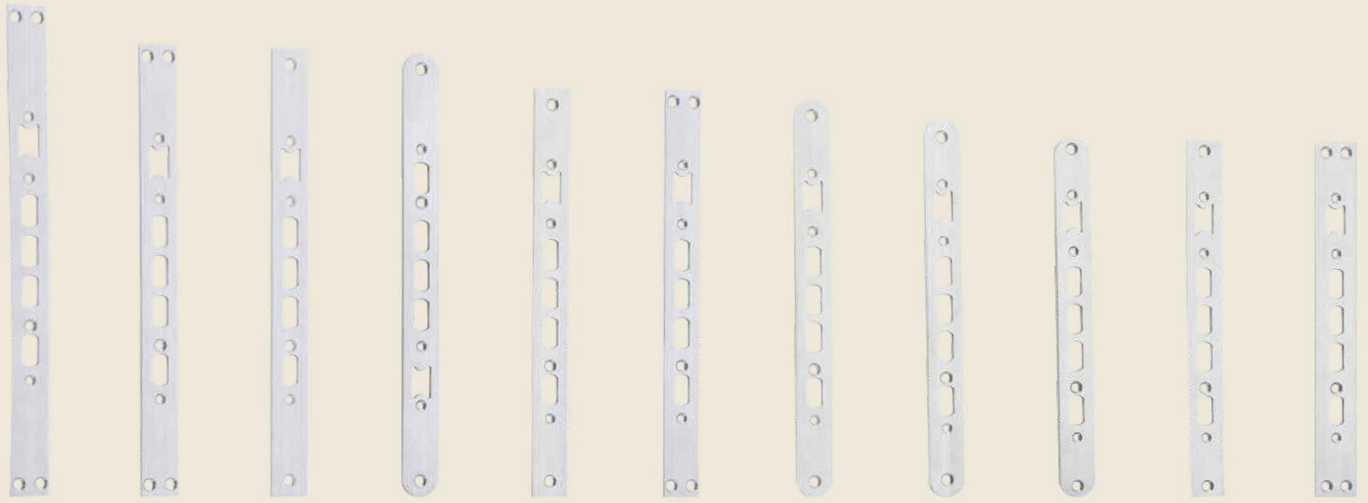

30cm 28cm 28cm 28cm 26cm 26cm 26cm 25cm 24cm 24cm 30*240cm

9# 异形锁条

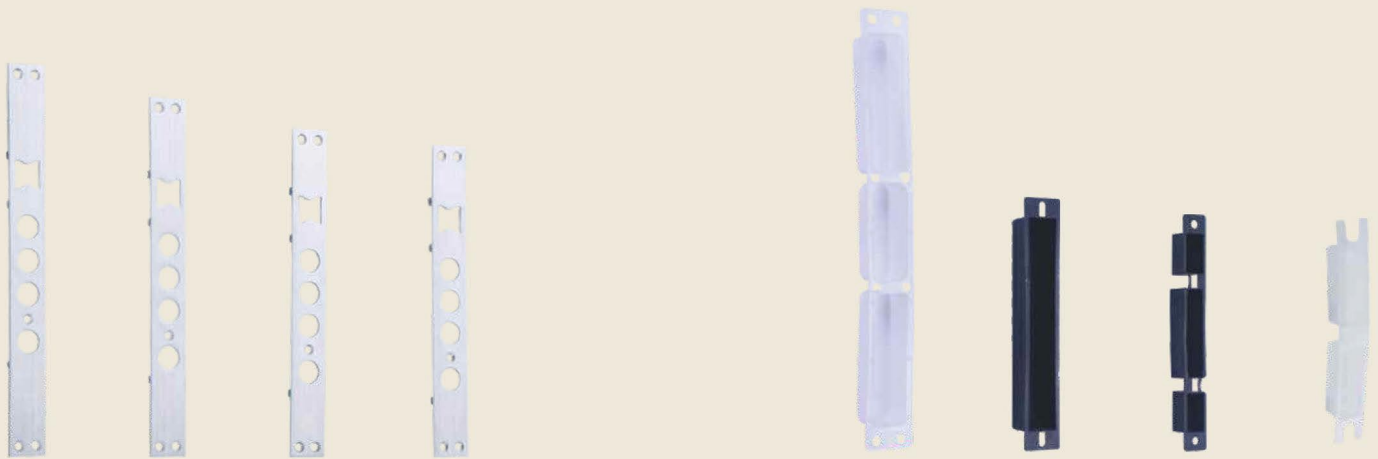

30cm 28cm 26cm 25cm 11#塑料盒 10#塑料盒 9#塑料盒 室内门塑料盒

10# 异形锁条



11#-1 扣板 11# 8孔扣板 11# 6孔扣板 10# 扣板 9# 扣板 耳朵扣板 木门扣板 10# (1.5厚) 扣板 55# 扣板 室内门扣板 室内门扣板 室内门扣板

外贸锁/拉手系列

FOREIGN TRADE LOCKS/DOOR HANDIES





JMD01



JM5801



JM5802



JM8503



JMF04



JMF05



JMF06



JMF07



JMF08



JMF09



JMF10

Stainless Steel Lever on Rose

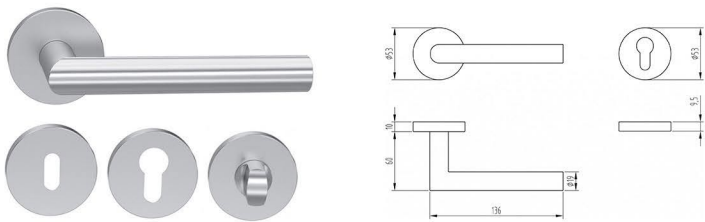

features:

- * Stainless steel tube lever, material grade 304
- * Rose substructure: steel, steel with tap, plastic
- * Profile spindle: 7mm, 8mm, 9mm available
- * Rose concealed with bolt through fixings
- * Surface: SSS (satin brushed), PSS (polished), BK (black), PVD
- * Versions: BB (key hole), PZ (cylinder hole), WC (toilet)
- * According to EN1906

Model: JM100

Surface:	SSS	PSS	BK	PVD
Versions:	BB	PZ	WC	

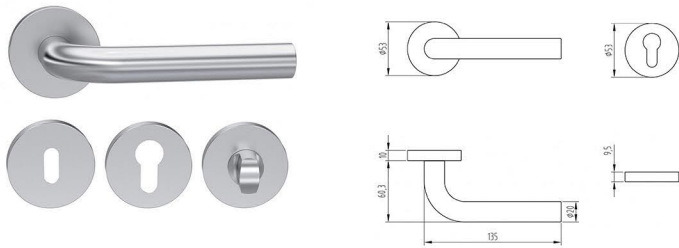

Model: JM101

Surface:	SSS	PSS	BK	PVD
Versions:	BB	PZ	WC	

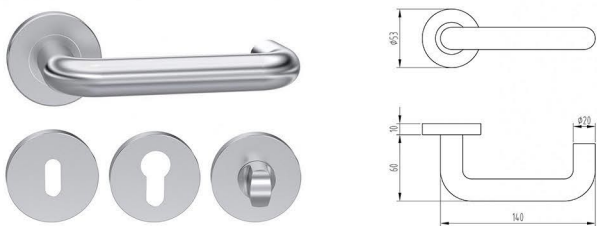

Model: JM102

Surface:	SSS	PSS	BK	PVD
Versions:	BB	PZ	WC	

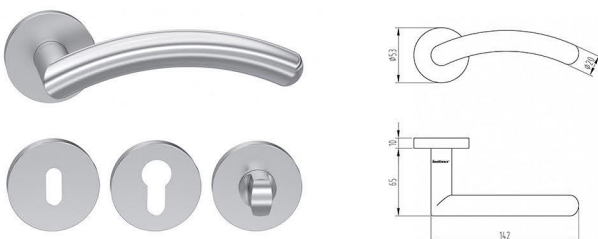

Model: JM103

Surface:	SSS	PSS	BK	PVD
Versions:	BB	PZ	WC	

Stainless Steel Lever on Rose

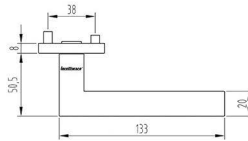
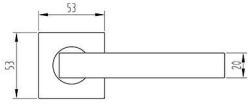

features:

- * Stainless steel tube lever, material grade 304
- * Rose substructure: steel, steel with tap, plastic
- * Profile spindle: 7mm, 8mm, 9mm available
- * Rose concealed with bolt through fixings
- * Surface: SSS (satin brushed), PSS (polished), BK (black), PVD
- * Versions: BB (key hole), PZ (cylinder hole), WC (toilet)
- * According to EN1906

Model: JM104

Surface:	SSS	PSS	BK	PVD
Versions:	BB	PZ	WC	

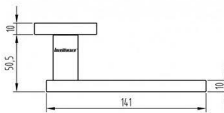
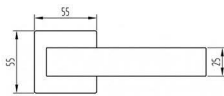
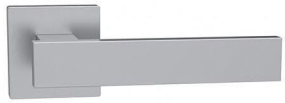

Model: JM105

Surface:	SSS	PSS	BK	PVD
Versions:	BB	PZ	WC	

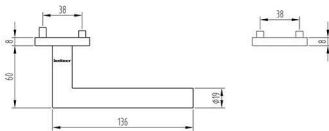

Model: JM106

Surface:	SSS	PSS	BK	PVD
Versions:	BB	PZ	WC	

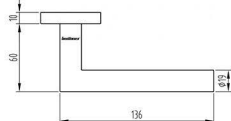
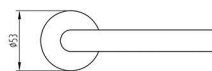

Model: JM107

Surface:	SSS	PSS	BK	PVD
Versions:	BB	PZ	WC	



JM YN01



JM YN02



JM YN03



JM YN04



JM YN05



JM YN51



JM YN06



JM YN07



JM YN08



JM YN09



JM8501



JM8502



JM8503



JM8504



JM8505



JM8506



JM8507

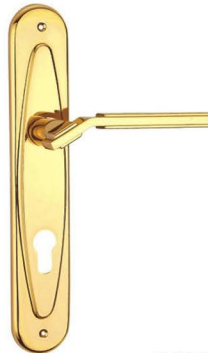

JM8508



JM8509



JM8510



JMF01



JMF02



JM-5001



JM-5004



YN-04



JM-50SS



JM-55



JM-55D



JMF-01



JMF-02



JMF-58SS



JM-7201



JM-7202



JM-7203



JM-YN05



JM-YN51



JM-31



JM-61



JM-11



JM-51



JM-52



JM-21



JMC8



JMC2



JMC1



JMC4



JMC5



JMC6



JMC9



JMC10



JMC11



JMC12



JMC13



JMC15



Zhejiang Wuyi Jiamin Locks Co.,Ltd

Add: No.204, Shuangyan Road,Wangzhai Industrial Zone,
Wuyi County,Jinhua City, 321200, Zhejiang, China

Tel:+86-(0)-579-87725226

Mobile: +86-(0)15858955138, +86-(0)13906795692

Email:aaronw@locks-factory.com

www.locks-factory.com